



SUPVAN

Johannesburg Branch

MIMIC COMPONENTS

Cape Town Branch

Mimic Cape

2022 CATALOG

Wire Tube & Label Printers
Professional Identification Solution Provider



Contents

Mini Thermal Label Printer

T50M	01
Consumables of T50M	02
E10	03
Consumables of E10	04

Label Printer

LP5120M (Stocked Locally)	07
LP5125M (Stocked Locally)	08
LP6185A	09
LP6245A	10
Consumables of LP Series	11

Wire Tube Printer

TP70E	13
TP76E (Stocked Locally)	14
TP80E (Stocked Locally)	15
Consumables of TP Series	16

Heat Shrink Tube Printer

TP2000M	18
Consumables of TP2000M	19

Plate Printer

SP650E	20
Consumables of SP650E	21



Letter of Manufacturer

First of all, thank you for your interest in our company's products.

As an outstanding supplier of identification products in China, in the past 20 years, we have been constantly exploring and developing new identification products to meet the different needs of different customers. We believe that there is always one of SUPVAN identification products that can meet your needs.

SUPVAN
Organized, Simple, Done.

Consumables of T50M

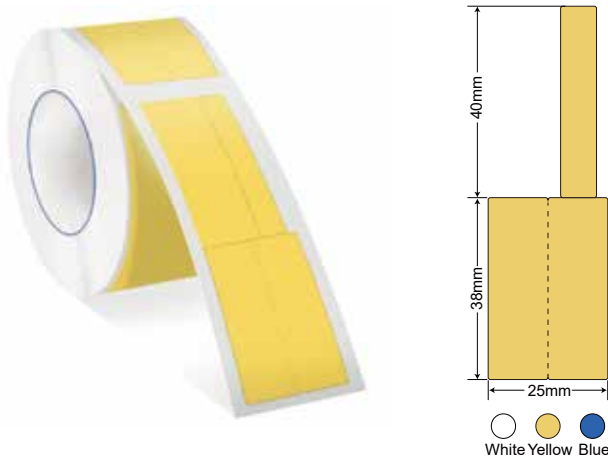

Consumable Type	Thermal Cable Label
Model No.	T0316E/T0318E/T0319E
Specification	(25mm*38mm+40mm)*100pcs/roll

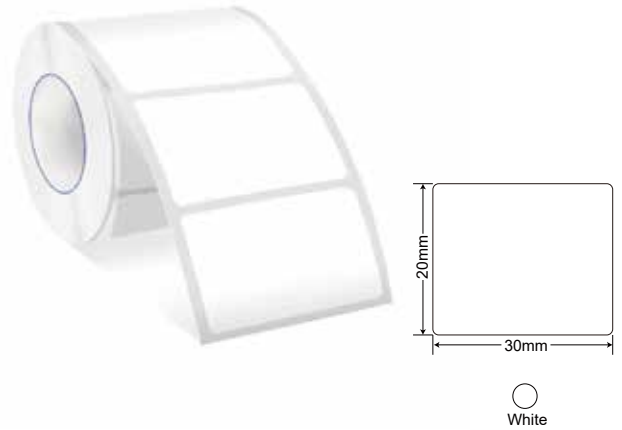

Consumable Type	Thermal Label
Model No.	T0508E
Specification	30mm*20mm*280pcs/roll

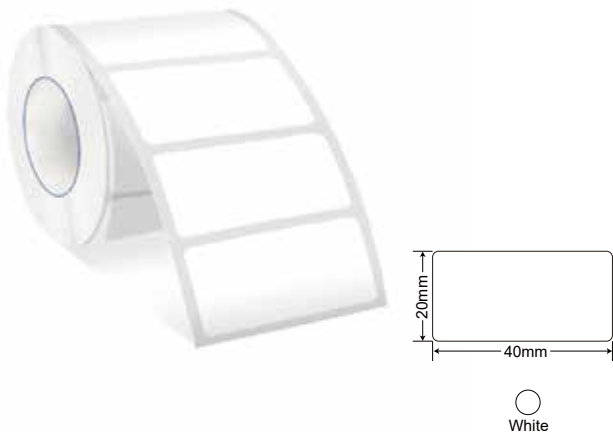

Consumable Type	Thermal Label
Model No.	T050BE
Specification	40mm*20mm*320pcs/roll

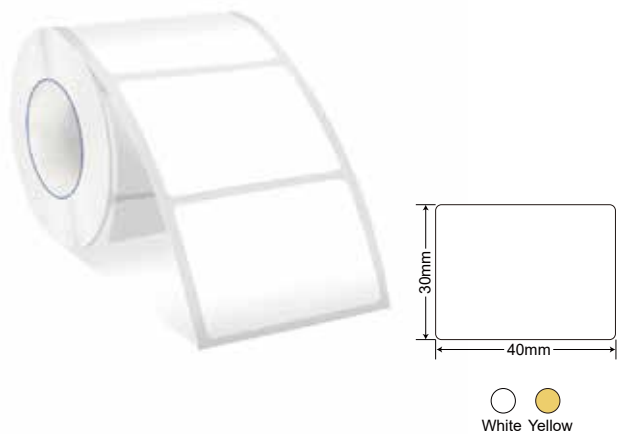

Consumable Type	Thermal Label
Model No.	T050CE/T050DE
Specification	40mm*30mm*250pcs/roll

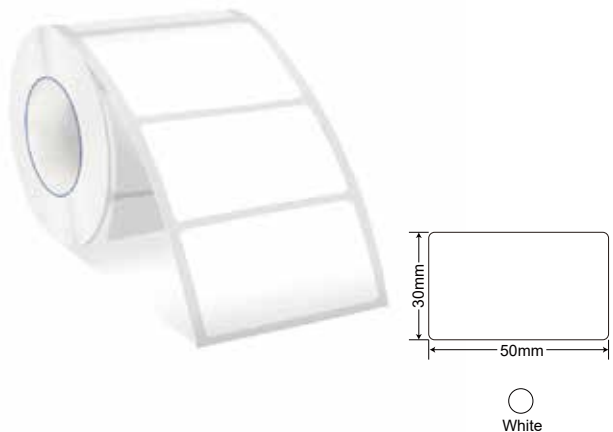

Consumable Type	Thermal Label
Model No.	T0515E
Specification	50mm*30mm*250pcs/roll

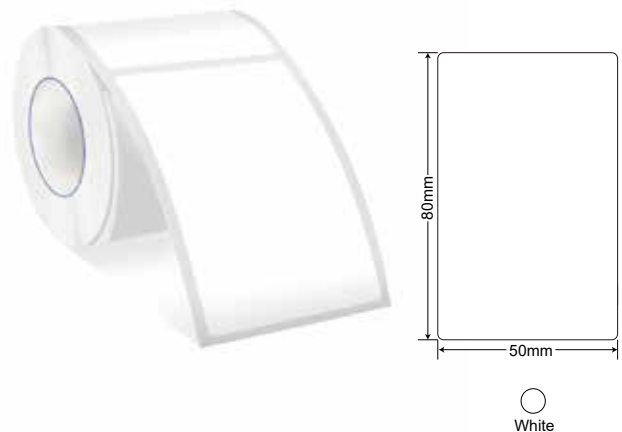

Consumable Type	Thermal Label
Model No.	T051AE
Specification	50mm*80mm*100pcs/roll

Mini Thermal Label Printer

- 1 Portable design, small size to take.
- 2 App support 17 kinds of language, popular with more customers.
- 3 Connect with phone App by Bluetooth function to edit text, symbol, frame, Barcode, QR code, etc.
- 4 Built-in "Cut down" Button to full cut label paper easily.
- 5 Support print continuous label and die-cut label.



E10

Application



Specification

Project	Parameter
Model	E10
Printing method	Thermal printing
Printing speed	30-60mm/s
Color	White Pink Green Black
Resolution	203 dpi
Effective printing width	12mm
Paper width	15mm (max.)
Paper type	Thermal paper
Interface	Bluetooth
Battery capacity	1200mAh
Supported languages	Chinese, English, Japanese, Korean and other languages.
Physical demention	130*78*28mm (W*D*H)
Net weight	200g
Operation	Free APP compatible with iOS and Android

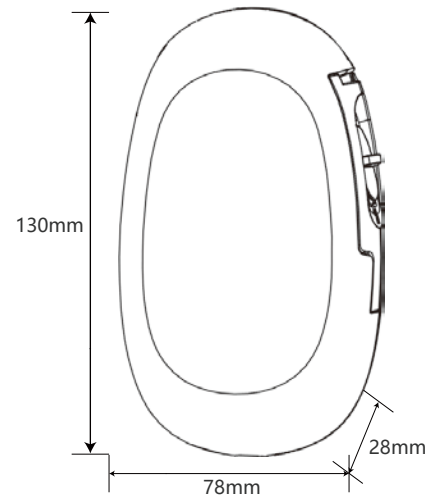

Included Items



Packing box x 1



E10 printer x 1



User Manual x 1



White label paper
12*30mm*220pcs x 1



Charger x 1

Consumables of E10

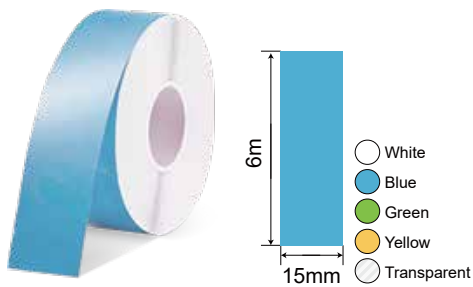

Consumable Type	Continuous Label
Model No.	AAE15*6m/ADE15*6m/ACE15*6m/ABE15*6m/BNE15*6m
Specification	15mm*6m/roll



Consumable Type	Fruit Continuous Label
Model No.	BBE15*6m
Specification	15mm*6m/roll

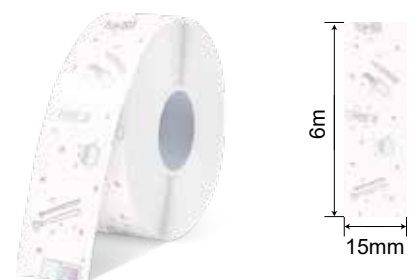

Consumable Type	Cosmetics Continuous Label
Model No.	BCE15*6m
Specification	15mm*6m/roll

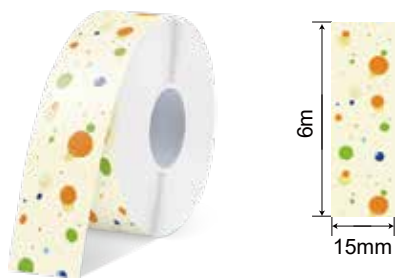

Consumable Type	Dots Continuous Label
Model No.	BDE15*6m
Specification	15mm*6m/roll



Consumable Type	Leaf Continuous Label
Model No.	BEE15*6m
Specification	15mm*6m/roll



Consumable Type	Heart Continuous Label
Model No.	BFE15*6m
Specification	15mm*6m/roll

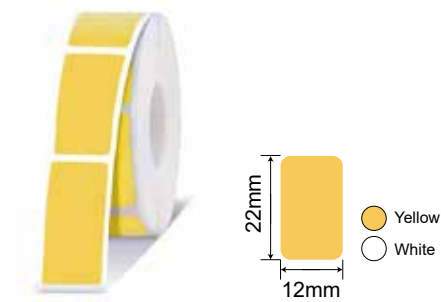

Consumable Type	Die-Cut Label
Model No.	ABE12*22/AAE12*22
Specification	12mm*22mm*280pcs/roll

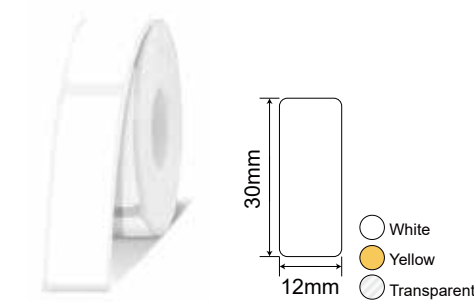

Consumable Type	Die-Cut Label
Model No.	AAE12*30/ABE12*30/BNE12*30
Specification	12mm*30mm*220pcs/roll

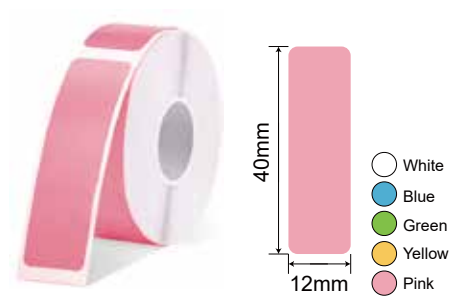

Consumable Type	Die-Cut Label
Model No.	AAE12*40/ADE12*40/ACE12*40/ABE12*40/AEE12*40
Specification	12mm*40mm*170pcs/roll

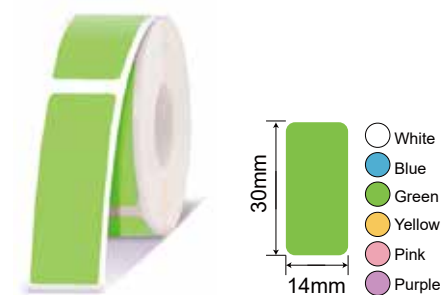

Consumable Type	Die-Cut Label
Model No.	T0970E14*30/T0973E14*30/T0974E14*30/T0971E14*30/T0972E14*30/T0975E14*30
Specification	14mm*30mm*220pcs/roll

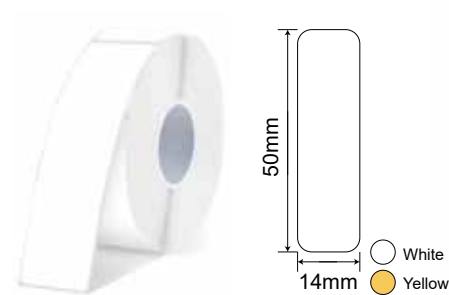

Consumable Type	Die-Cut Label
Model No.	T0976E14*50/T0977E14*50
Specification	14mm*50mm*140pcs/roll

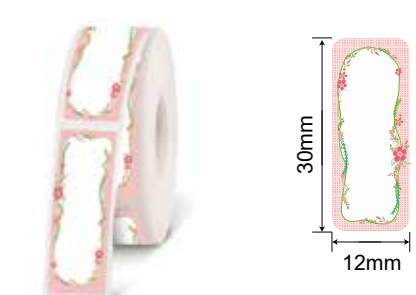

Consumable Type	Flower Die-Cut Label
Model No.	AUE12*30
Specification	12mm*30mm*220pcs/roll

Consumables of E10

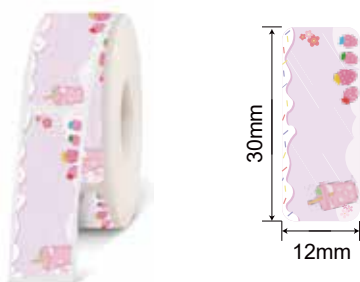

Consumable Type	Romance Of A Teenage Girl Die-Cut Label
Model No.	AVE12*30
Specification	12mm*30mm*220pcs/roll

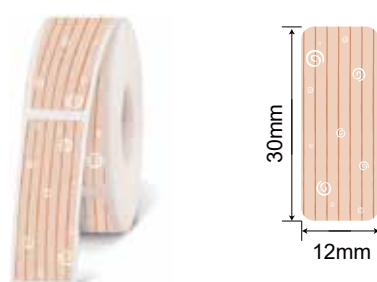

Consumable Type	Stripes Die-Cut Label
Model No.	AWE12*30
Specification	12mm*30mm*220pcs/roll

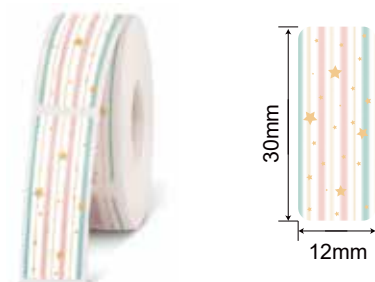

Consumable Type	Star Stripes Die-Cut Label
Model No.	ATE12*30
Specification	12mm*30mm*220pcs/roll

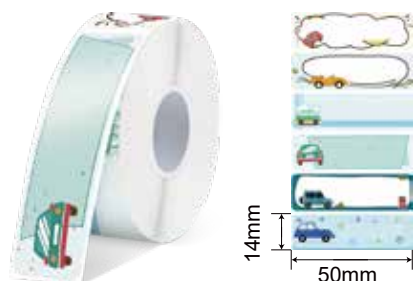

Consumable Type	Cool Car Die-Cut Label
Model No.	T0965E14*50
Specification	14mm*50mm*140pcs/roll

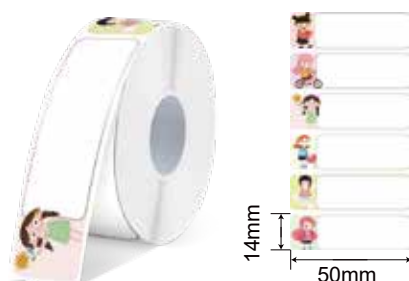

Consumable Type	Pretty Princess Die-Cut Label
Model No.	T0966E14*50
Specification	14mm*50mm*140pcs/roll

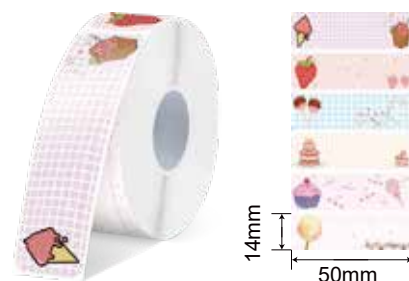

Consumable Type	Dessert Die-Cut Label
Model No.	T0967E14*50
Specification	14mm*50mm*140pcs/roll

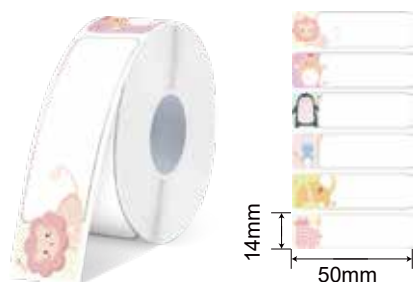

Consumable Type	Tiny Animal Die-Cut Label
Model No.	T0968E14*50
Specification	14mm*50mm*140pcs/roll

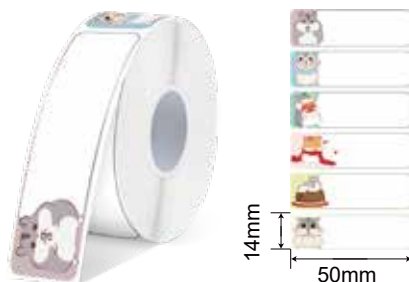

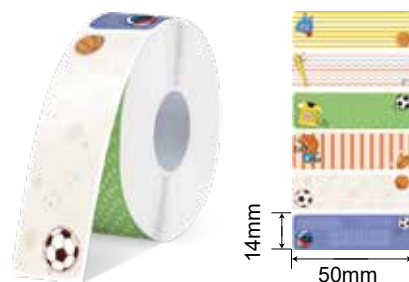

Consumable Type	Cute Hamsters Die-Cut Label
Model No.	T0969E14*50
Specification	14mm*50mm*140pcs/roll



Consumable Type	Sports Player Die-Cut Label
Model No.	T0964E14*50
Specification	14mm*50mm*140pcs/roll

Specification Comparison

Model	E10	T50M
Picture		
Product Type	Label Printer	Label Printer
Color	White, Pink, Green, Black	Green+White
Model	E10	T50M
Printing Method	Thermal Printing	Thermal Printing
Paper Type	Thermal Paper	Thermal Paper
Print Accuracy	203 dpi	203 dpi
Paper width	15mm (max.)	20mm ~ 50mm
Effective Printing Width	12mm	48mm
Print Speed	30-60mm/s	60mm/s
Battery Capacity	1200mAh	1200mAh
Supported Languages	Chinese, English, Japanese, Korean, Arabic, Russian, Thai, Vietnamese, Indonesian, German, Fresh, Italian, Spanish, Portuguese, Turkish, Czech, Dutch	Chinese, English, Japanese, Korean, Arabic, Russian, Thai, Vietnamese, Indonesian, German, Fresh, Italian, Spanish, Portuguese, Turkish, Czech, Dutch
Product Size	130mm*78mm*28mm	125mm×85mm×60mm
Weight	200g	260g
Data Transfer	Bluetooth 4.2	Bluetooth 4.2
Power	5V-1A	5V-1A
Operating Environment	10℃ ~ 35℃	10℃ ~ 40℃
Storage Environment	-10℃ ~ 55℃	-5℃ ~ 55℃
Operating Humidity	20% ~ 80% No condensation	20% ~ 80% No condensation
Storage Humidity	5%-80% No condensation	5%-80% No condensation
Operation	Free APP compatible with iOS and Android	Free APP compatible with iOS and Android

Label Printer **STOCKED LOCALLY**

- ① Support 6mm/9mm/12mm width label.
- ② Support 17 kinds of system language, popular with more customers.
- ③ Preload 1356 symbols & some frames, usage of office, warning, transport, bless, sale, etc.
- ④ Up to 50 labels can be printed one time, apply to print lots of labels.



LP5120M

Application



Specification

Project	Parameter
Model	LP5120M
Printing Method	Thermal Transfer
Resolution	203dpi
Printing Speed	20mm/s
Keyboard	QWERTY layout
Display	LCD, White Back-lit, 2 line info display on screen
Input modes	English, Numbers, Bar codes, QR codes, Symbols
Max. Height of Letter	9mm
Multi-Lines	Max. 4 lines of content
Fonts available	3 fonts supported
Symbol Library	1356
System Language	Support 17 kind of languages
Cutting Mode	Manual full cut
Power	AC 9V 2.5A
Power Options	Alkaline AA dry battery, Adapter
Optional Accessories	Adapter (Not include)
Operating Environment	Temperature: 10°C~35°C; RH: 20%~80%RH
Weight	400g
Measurement	203mm*108mm*56mm

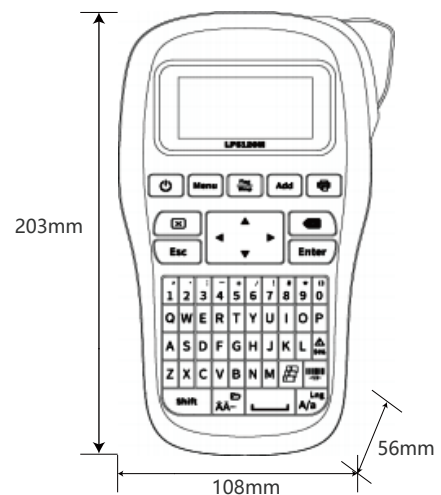

Included Items



Packing box x 1



LP5120M printer x 1



Label Tape x 1



User Manual x 1

Label Printer STOCKED LOCALLY

- 1 Support 6mm/9mm/12mm width label.
- 2 Support 17 kinds of system language, popular with more customers.
- 3 Preload 1356 symbols & some frames, usage of office, warning, transport, bless, sale, etc.
- 4 Up to 50 labels can be printed one time, apply to print lots of labels.
- 5 Automatically full cut to make print lots of labels easily.



LP5125M

Application

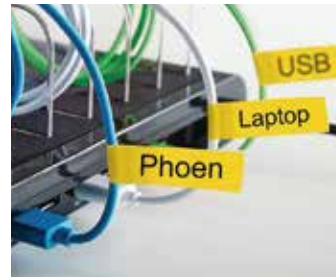
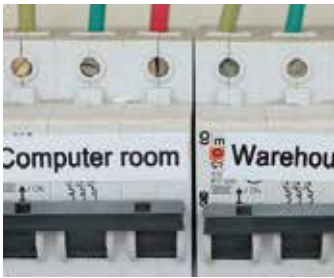

Specification

Project	Parameter
Model	LP5125M
Printing Method	Thermal Transfer
Resolution	203dpi
Display	LCD, White Back-lit, 2 line info display on screen
Keyboard	ABC layout, 54 keys
Input modes	English, Numbers, Bar codes, QR codes, Symbols
Max. Height of Letter	9mm
Multi-Lines	Max. 4 lines of content
Fonts available	8 fonts supported
Frames available	Yes
Model available	17
Symbol Library	1356
Printing Speed	20mm/s
Cutting Mode	Automatic full cut
System Language	Support 17 kinds of system language
Max. Segments No.	50 segments, editable & printable one time
File storage	64 files can be stored, each file 50 segments
Power	AC 9V 2.5A
Power Options	Alkaline AA dry battery, Lithium Battery, Adapter,
Optional Accessories	Lithium Battery (optional), Hard Plastic Case (optional)
Operating Environment	Temperature: 10°C~35°C; RH: 20%~80%RH
Weight	630g
Measurement	222mm*120mm*66mm
Warranty	Whole Machine 1 years

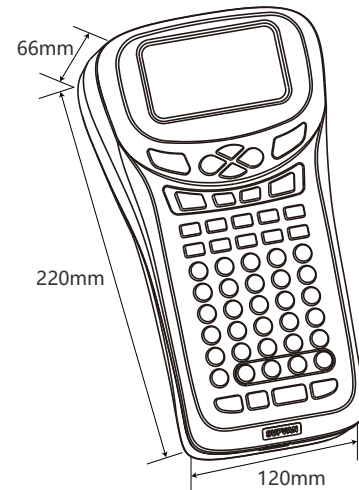

Included Items



Packing box x 1



LP5125M printer x 1



Power Adapter x 1



Label Tape x 1



User Manual x 1



Lithium Battery x 1



Suitcase x 1

Label Printer

- ① Support 6mm/9mm/12mm/18mm width label printing.
- ② Preload 1356 symbols & some frames, usage of office, warning, transport, bless, sale, etc.
- ③ Up to 50 labels can be printed one time, apply to print lots of labels.
- ④ Automatically full cut to make print lots of labels easily.
- ⑤ Support print Barcode and QR code.
- ⑥ USB PC connection, import data from excel, make labels in bulk on PC.



LP6185A

Application



Specification

Project	Parameter
Model	LP6185A
Printing Method	Thermal Transfer
Consumable Width	6mm/9mm/12mm/18mm
Max. Height of Letter	16mm
Muti-Lines	Max 7 lines of content
Cutting Mode	Automatic full cut
Display	LCD,White Back-lit, 2 line info display en screen
Resolution	203dpi
Keyboard	QWERTY layout, 56 keys
Input modes	English,Numbers,Bar codes,QR codes,Symbols
Fonts available	8 fonts supported
Frames available	4+PC software more versions
System Language	English Only
Symbol Library	1356
Printing Speed	20mm/s
Max. Segments No.	50 segments, editable & printable one time
File storage	64 files can be stored, each file 50 segments
Power	AC 9V 2.5A
Power Options	Alkaline 6AA battery, Lithium battery, Adapter
Accessories	Lithium battery, Hard Plastic Case ,Adapter,
Operating Environment	Temperature: 10℃-35℃:RH: 20%~80%RH
Weight	690g
Measurement	174*154*72mm
Warranty	Whole Machine 1 year
PC software	Win 7, Win 10

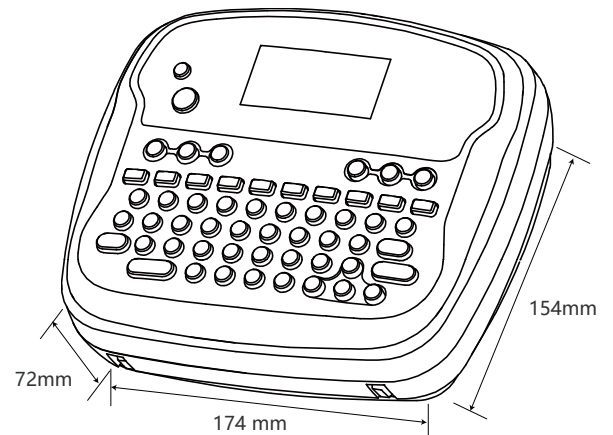

Included Items

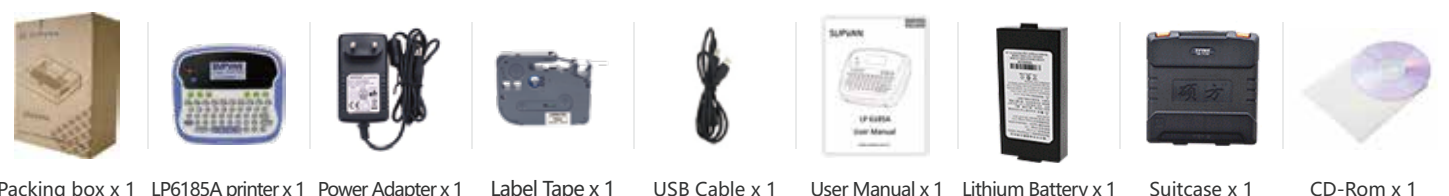

Packing box x 1 LP6185A printer x 1 Power Adapter x 1 Label Tape x 1 USB Cable x 1 User Manual x 1 Lithium Battery x 1 Suitcase x 1 CD-Rom x 1

Label Printer

- 1 Support 6mm/9mm/12mm/18mm/24mm width label printing
- 2 Preload 1356 symbols & some frames, usage of office, warning, transport, bless, sale, etc.
- 3 Up to 50 labels can be printed one time, apply to print lots of labels.
- 4 Automatically full cut to make print lots of labels easily.
- 5 Support print Barcode and QR code.
- 6 USB PC connection, import data from excel, make labels in bulk on PC.



LP6245A

Application



Specification

Project	Parameter
Model	LP6245A
Printing Method	Thermal Transfer
Consumable Width	6mm/9mm/12mm/18mm/24mm
Max. Height of Letter	18 mm
Muti-Lines	Max. 9 lines of content
Cutting Mode	Automatic full cut
Display	LCD, White Back-lit, 2 line info display on screen
Resolution	203dpi
Keyboard	QWERTY layout, 56 keys
Input modes	English, Numbers, Bar codes, QR codes, Symbols
Fonts available	8 fonts supported
Frames available	4+PC software more versions
System Language	English Only
Symbol Library	1356
Printing Speed	20mm/s
Max. Segments No.	50 segments, editable & printable one time
File storage	64 files can be stored, each file 50 segments
Power	AC 9V 3.5A
Power Options	Alkaline 6AA battery, Lithium battery, Adapter
Accessories	Lithium battery, Hard Plastic Case ,Adapter,
Operating Environment	Temperature: 10°C~35°C; RH: 20%~80%RH
Weight	700g
Measurement	160mm * 129mm * 65mm
Warranty	Whole Machine 1 year
PC software	Win 7, Win 10

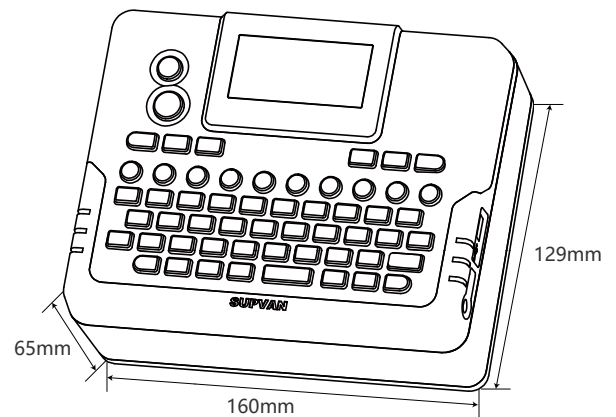

Included Items



Packing box x 1 LP6245A printer x 1 Power Adapter x 1 Label Tape x 1 USB Cable x 1 User Manual x 1 Lithium Battery x 1 Suitcase x 1 CD-Rom x 1

Consumables of LP Series



SUPVAN Label Tape	
Width	6mm/9mm/12mm/18mm/24mm
Length	8m
Print type	Label sticker

Consumables of LP5120M, LP5125M, LP6185A, LP6245A



Name	Colour	Specification				
		6mm*8m/roll	9mm*8m/roll	12mm*8m/roll	18mm*8m/roll	24mm*8m/roll
Non-Laminated Tape	White Label Black Ink	–	L-A221E	L-A231E	L-A241E	L-A251E
	Yellow Label Black Ink	–	L-A621E	L-A631E	L-A641E	L-A651E
Strong Adhesive Tape	White Label Black Ink	–	L-P221E	L-P231E	L-P241E	L-P251E
	Yellow Label Black Ink	–	L-P621E	L-P631E	L-P641E	L-P651E
Laminated Tape	White Label Black Ink	L-211E	L-221E	L-231E	L-241E	L-251E
	White Label Red Ink	–	L-222E	L-232E	L-242E	L-252E
	White Label Blue Ink	–	L-223E	L-233E	L-243E	L-253E
	Clear Label Black Ink	L-111E	L-121E	L-131E	L-141E	L-151E
	Clear Label White Ink	–	–	L-135E	L-145E	L-155E
	Clear Label Red Ink	–	–	L-132E	–	–
	Clear Label Blue Ink	–	–	L-133E	–	–
	Yellow Label Black Ink	L-611E	L-621E	L-631E	L-641E	L-651E
	Black Label White Ink	L-315E	L-325E	L-335E	L-345E	L-355E
	Red Label Black Ink	–	L-421E	L-431E	L-441E	L-451E
	Red Label White Ink	–	–	L-435E	–	–
	Blue Label Black Ink	–	L-521E	L-531E	L-541E	L-551E
	Blue Label White Ink	–	–	L-535E	–	L-555E
	Green Label Black Ink	–	L-721E	L-731E	L-741E	L-751E
Green Label White Ink	–	–	L-735E	–	L-755E	
Matte Silver Label Black Ink	–	–	L-831E	L-841E	L-851E	

Specification Comparison

Model	LP5120M	LP5125M	LP6185A	LP6245A
Picture				
Printing Method	Thermal Transfer	Thermal Transfer	Thermal Transfer	Thermal Transfer
Cutting Mode	Manual	Automatic full cut	Automatic full cut	Automatic full cut
Display	LCD, White Back-lit, 2 line info display on screen	LCD, White Back-lit, 2 line info display on screen	LCD, White Back-lit, 2 line info display on screen	LCD, White Back-lit, 2 line info display on screen
Display Backlight	×	√	√	√
Resolution	203dpi	203dpi	203dpi	203dpi
Keyboard	QWERTY layout, 56 keys	ABC layout, 54 keys	QWERTY layout, 54 keys	QWERTY layout, 54 keys
Fuction Shortcut Keys	×	√	√	√
Label Width	6mm, 9mm,12mm	6mm, 9mm,12mm	6mm, 9mm, 12mm,18mm	6mm, 9mm, 12mm, 18mm,24mm
Printing Speed	20mm/s	20mm/s	20mm/s	20mm/s
Input modes	English, Numbers, Bar codes, QR codes, Symbols	English, Numbers, Bar codes, QR codes, Symbols	English, Numbers, Bar codes, QR codes, Symbols	English, Numbers, Bar codes, QR codes, Symbols
Max. Height of Letter	9 mm	9 mm	16 mm	18 mm
Multi-Lines	Max. 4 lines of content	Max. 4 lines of content	Max. 7 lines of content	Max. 9 lines of content
Max. Segments No.	50 segments, editable & printable one time	50 segments, editable & printable one time	50 segments, editable & printable one time	50 segments, editable & printable one time
File Sotrage	64 files can be stored, each file up to 50 segments	64 files can be stored, each file up to 50 segments	64 files can be stored, each file up to 50 segments	64 files can be stored, each file up to 50 segments
Fonts available	3 fonts supported	8 fonts supported	8 fonts supported	8 fonts supported
Frames available	Yes	Yes	4+PC software more versions	4+PC software more versions
Symbol Library	1356	1356	1356	1356
Frames available	Built-in 17 kinds of language(English, čeština, Slovenčina, Polski, Deutsch, Español, Français, Italiano, Русский , Magyar, Nederlands, Norsk, Português, Suomi, Svenska, Türkçe, Dansk)	Built-in 17 kinds of language(English, čeština, Slovenčina, Polski, Deutsch, Español, Français, Italiano, Русский , Magyar, Nederlands, Norsk, Português, Suomi, Svenska, Türkçe, Dansk)	English Only	English Only
PC software	×	×	Win 7, Win 10	Win 7, Win 10
Power	AC 9V 2.5A	AC 9V 2.5A	AC 9V 3.5A	AC 9V 3.5A
Power Options	Alkaline 6AA battery(not include), Adapter(optional, not include)	Alkaline 6AA battery(not include), Adapter(optional, not include)	Alkaline 6AA battery(not include), Adapter(optional, not include)	Alkaline 6AA battery(not include), Adapter(optional, not include)
Accessories	Adapter (optional, not include)	Lithium Battery&AC power Adapter(in- clude), Hard Plastic Case(include)	Lithium Battery&AC power Adapter(in- clude), Hard Plastic Case(include)	Lithium Battery&AC power Adapter(in- clude), Hard Plastic Case(include)
Operating Environment	Temperature: 10°C ~ 35°C; RH: 20% ~ 80%RH	Temperature: 10°C ~ 35°C; RH: 20% ~ 80%RH	Temperature: 10°C ~ 35°C; RH: 20% ~ 80%RH	Temperature: 10°C ~ 35°C; RH: 20% ~ 80%RH
Weight	400g	630g	690g	700g
Measurement	203*108*56mm	222*120*66mm	174*154*72mm	160*129*65mm

Wire Tube Printer

- ① Different printing materials: tube/ heat shrink tube (2.5-6mm diameter), label (6mm/9mm/12mm width).
- ② Large white back-lit LCD display, up to 2 lines display on TP70E.
- ③ Automatic feed/clean/ribbon pre tighten/half cut/full cut.
- ④ 85-key standard keyboard makes operation easily.
- ⑤ Repeat, sequence and copy print functions can save your time.
- ⑥ Large internal storage capacity can store up to 200 files.



TP70E

Application



Specification

Project	Parameter
Model	TP70E
Printing method	Thermal transfer
Resolution	300dpi
Printing speed	Tube:35pcs/min,20mm/pcs Label:35pcs/min,20mm/pcs
Ink Ribbon	Black:100m,White:80m,Red:80m
Input modes	Alphanumeric, Symbol, English character input
Character size	Label:1-7 Tube:1-5
Repeat	1-200
Media cutting method	Automatic half-cutting, Automatic full-cutting
Styles	Frame, Underline, Superscript, Subscript,
Tape type	Tube, Heat shrink tube, Label
Keyboard	85keys standard keyboard
Dimension(L×W×H)	320mm*280mm*80mm
Weight	3kg(printer only)
Power supply	AC adapter(Input voltage: AC 100V-240V 50/60Hz)
Display	White back-lit LCD display; Up to 2-line editing interface
Internal memory	Up to 200 files 200 paragraph/file (12,000,000 characters)
Operating environment	15 C -35 C
PC interface	No
Tube	PVC tubeΦ2.5-Φ6mm, Heat shrink tube Φ2.5-Φ6mm
Label	Exclusive cassettes(White, yellow, silver) Width:6mm, 9mm, 12 mm.Length:16m

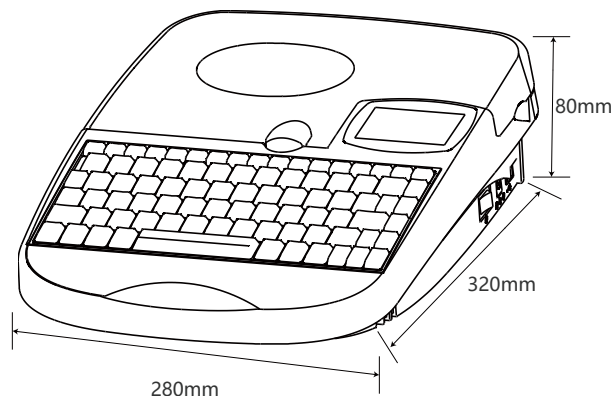

Included Items



Packing box x 1 TP70E printer x 1 Suitcase x 1 Power Adapter x 1 Label Cassette x 1 Tube Adjuster x 1 Power line x 1 Ribbon Cassette x 1 User Manual x 1 Quality Certificate x 1

Wire Tube Printer **STOCKED LOCALLY**

- ① Different printing materials: tube/ heat shrink tube (2.5-6mm diameter), label (6mm/9mm/12mm width).
- ② Large white back-lit LCD display, up to 2 lines display on TP76E.
- ③ Automatic feed/clean/ribbon pre tighten/half cut/full cut.
- ④ 85-key standard keyboard makes operation easily.
- ⑤ Repeat, sequence and copy print functions can save your time.
- ⑥ USB PC link, professional editing software.
- ⑦ Large internal storage capacity can store up to 200 files.



TP76E

Application



Specification

Project	Parameter
Model	TP76E
Printing method	Thermal transfer
Resolution	300dpi
Printing speed	Tube:35pcs/min,20mm/pcs Label:35pcs/min,20mm/pcs
Ink Ribbon	Black: 100m,White:80m,Red:80m
Input modes	Alphanumeric, Symbol, English character input
Character size	Label:1-7 Tube:1-5
Repeat	1-200
Media cutting method	Automatic half-cutting, Automatic full-cutting
Styles	Frame, Underline, Superscript, Subscript
Tape type	Tube, Heat shrink tube, Label
Keyboard	85keys standard keyboard
Dimension(L×W×H)	320mm*280mm*80mm
Weight	3kg(printer only)
Power supply	AC adapter(Input voltage: AC 100V-240V 50/60Hz)
Display	White back-lit LCD display; Up to 2-line editing interface
Internal memory	Up to 200 files 200 paragraph/file (12,000,000 characters)
Operating environment	15 C -35 C
PC interface	USB2.0 Full-speed, Professional editing software
Tube	PVC tubeΦ2.5-Φ6mm Heat shrink tube Φ2.5-Φ6mm
Label	Exclusive cassettes(White, yellow, silver) Width:6mm, 9mm, 12 mm.Length:16m
Insert Stick Plate	Not Applicable

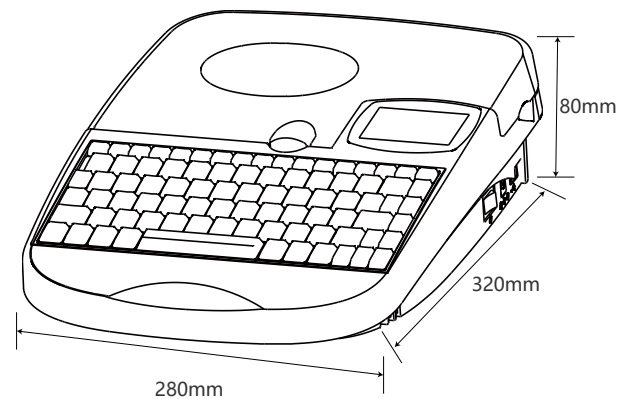

Included Items



Packing box x 1 TP76E printer x 1 Hand suitcase x 1 Power line x 1 Power adapter x 1 Label Cassette x 1 Tube Adjuster x 1 Ribbon Cassette x 1 USB cable x 1 User Manual x 1 CD-ROM x 1 Quality Certificate x 1

Wire Tube Printer **STOCKED LOCALLY**

- ① Different printing materials: tube/ heat shrink tube (2.5-6mm diameter), label (6mm/9mm/12mm width), plate 4mm/4.6mm/9mm.
- ② Large white back-lit LCD display, up to 10 lines display on TP80E.
- ③ Automatic feed/clean/ribbon pre tighten/half cut/full cut.
- ④ 85-key standard keyboard makes operation easily.
- ⑤ Repeat, sequence and copy print functions can save your time.
- ⑥ USB PC link, professional editing software.
- ⑦ Large internal storage capacity can store up to 200 files.



TP80E

Application

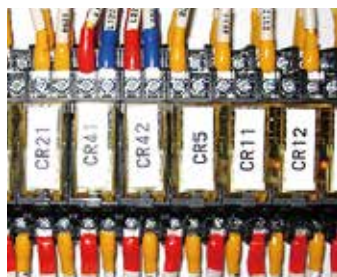

Specification

Project	Parameter
Model	TP80E
Printing method	Thermal transfer
Resolution	300dpi
Printing speed	Tube:40pcs/min,20mm/pcs Label:40pcs/min,20mm/pcs
Ink Ribbon	Black:100m,White:80m,Red:80m
Input modes	Alphanumeric, Symbol, English character input
Character size	Label:1-7 Tube:1-5
Repeat	1-200
Media cutting method	Automatic half-cutting, Automatic full-cutting
Styles	Frame, Underline, Superscript, Subscript
Tape type	Tube, Heat shrink tube, Label, Plate
Keyboard	85keys standard keyboard
Dimension(L×W×H)	320mm*280mm*100mm
Weight	3.2kg(printer only)
Power supply	AC adapter(Input voltage: AC 100V-240V 50/60Hz)
Display	White back-lit LCD display; Single and double column display; Up to 5-line editing interface
Internal memory	Up to 200 files 200 paragraph/file (12,000,000 characters)
External memory	SD card and card reader
Operating environment	15℃-35℃
PC interface	USB2.0 Full-speed, Professional editing software
Tube	PVC tubeΦ2.5-Φ6mm Heat shrink tube Φ2.5-Φ6mm
Label	Exclusive cassettes(White, yellow, silver) Widths:6mm, 9mm, 12 mm.Length:16m
Insert Stick Plate	Width:4mm, 4.6mm, 9mm

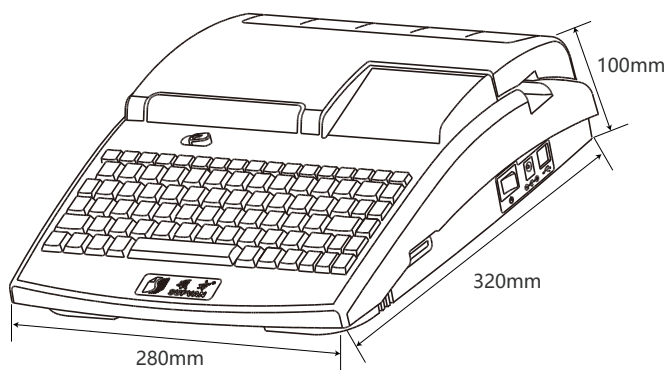

Included Items



Consumables of TP Series

Consumables of TP70E, TP76E, TP80E















TP70E

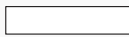
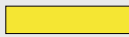

TP76E

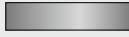

TP80E

Picture	Consumable Type	Model No.	Specification
 Ribbon	Black ribbon 	TP-R100EB	width: 12mm, length: 100 m/roll
	Red ribbon 	TP-R80ER	width: 12mm, length: 80 m/roll
	White ribbon 	TP-R80EW	width: 12mm, length: 80 m/roll
 label Picture	6mm white label 	TP-L06EW	width: 6mm, length: 16 m/roll
	6mm yellow label 	TP-L06EY	width: 6mm, length: 16 m/roll
	6mm silver label 	TP-L06ES	width: 6mm, length: 16 m/roll
	9mm white label 	TP-L09EW	width: 9mm, length: 16 m/roll
	9mm yellow label 	TP-L09EY	width: 9mm, length: 16 m/roll
	9mm silver label 	TP-L09ES	width: 9mm, length: 16 m/roll
	12mm white label 	TP-L12EW	width: 12mm, length: 16 m/roll
	12mm yellow label 	TP-L12EY	width: 12mm, length: 16 m/roll
	12mm silver label 	TP-L12ES	width: 12mm, length: 16 m/roll

Picture	Suit for Wire outer diameter	Size	Length(1kg/roll)
 PVC Tube	2.0mm	0.5 ²	145m
	2.3mm	0.75 ²	130m
	2.6mm	1.0 ²	112m
	3.2mm	1.5 ²	100m
	3.6mm	2.5 ²	72m
	4.2mm	4.0 ²	62m
	5.1mm	6.0 ²	48m
	6.3mm	8.0 ²	40m

Specification Comparison

Model	TP70E	TP76E	TP80E
Picture			
Product Type	Tube Printer	Tube Printer	Tube Printer
Printing Method	Thermal transfer	Thermal transfer	Thermal transfer
Resolution	300dpi	300dpi	300dpi
Media type	Tube, Heat shrink tube, Label	Tube, Heat shrink tube, Label	Tube, Heat shrink tube, Label, Plate
Character Size	Label:1-7 Tube:1-5	Label:1-7 Tube:1-5	Label:1-7 Tube:1-5 Plate:1-2
Length	6-100mm	6-100mm	6-100mm
Repeat	1-200	1-200	1-200
PC Connection	×	USB2.0 full-speed professional editing software	USB2.0 full-speed professional editing software
Printing Speed	Tube/Label: 35pcs/min, 20mm/pcs	Tube/Label: 35pcs/min, 20mm/pcs	Tube/Label/Plate: 40pcs/min, 20mm/pcs
Display	White back-lit LCD display; Up to 2-line editing interface	White back-lit LCD display; Up to 2-line editing interface	White back-lit LCD display; Single and double column display; Up to 5-line editing interface
Input Modes	English letters, Symbols	English letters, Symbols	English letters, Symbols
Internal Memory	Up to 200 files 200 paragraph/file (12,000,000 characters)	Up to 200 files 200 paragraph/file (12,000,000 characters)	Up to 200 files 200 paragraph/file (12,000,000 characters)
External Memory	×	×	SD card and card reader
Cutting Method	Automatic half cut, automatic full cut, solid line, none	Automatic half cut, automatic full cut, solid line, none	Automatic half cut, automatic full cut, solid line, none
Feeding Method	Automatic feed	Automatic feed	Automatic feed
Printing Material	Tube/Heat shrink tube: 2.5-6mm diameter Label: 6/9/12mm width	Tube/Heat shrink tube: 2.5-6mm diameter Label: 6/9/12mm width	Tube/Heat shrink tube: 2.5-6mm diameter Label: 6/9/12mm width Plate: 4/4.6/9mm width
Keyboard	85-Key standard keyboard	85-Key standard keyboard	85-Key standard keyboard
Power Supply	AC adapter (Input voltage: AC 100-240V 50/60 Hz)	AC adapter (Input voltage: AC 100-240V 50/60 Hz)	AC adapter (Input voltage: AC 100-240V 50/60 Hz)
Dimension (L*W*H)	320mm*280mm*80mm	320mm*280mm*80mm	320mm*280mm*100mm
Weight	3kg (printer only)	3kg (printer only)	3.2kg (printer only)
Operating Environment	15℃-35℃	15℃-35℃	15℃-35℃

Heat Shrink Tube Printer

- 1 Support print heat shrink tube 7mm-30mm diameter
- 2 High resolution 300dpi, make words clear.
- 3 High print speed 35mm/s, print quickly.
- 4 Automatic Half-cutting, easy to use.
- 5 USB PC connection, import data from excel, make tubes in bulk on PC.



TP2000M

Application

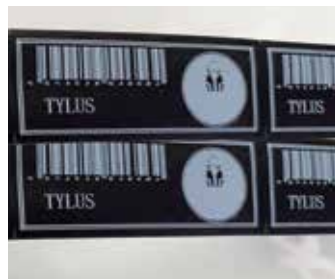

Specification

Project	Parameter
Model	TP2000M
Printing method	Thermal transfer
Resolution	300dpi
Display	No LCD devices
Printing speed	35mm/s
Cutting	Automatic Half-cutting
Max printable range	55mm
Ribbon Spec	62mm*45m, single color
Ribbon Color	Black, White, Golden
Heat Shrink Tube Size	Φ7.0-Φ30mm
Heat Shrink Tube Color	White, Yellow, Black
Connection Interface	USB 2.0 Full speed
Working temperature	15°C~35°C
Working humidity	15%-80% No condensation
Power Supply	15V 3A
Outer Dimensions	263mm*165mm*178mm
Weight	2.4KG
OS	Win8 / Win7/ Vista/ Windows XP/Win10 Compatible drivers/APPs are available on website once product publish
Warranty	Whole Printer 1 year
Consumables	Tube Support 、 Ribborn cassette

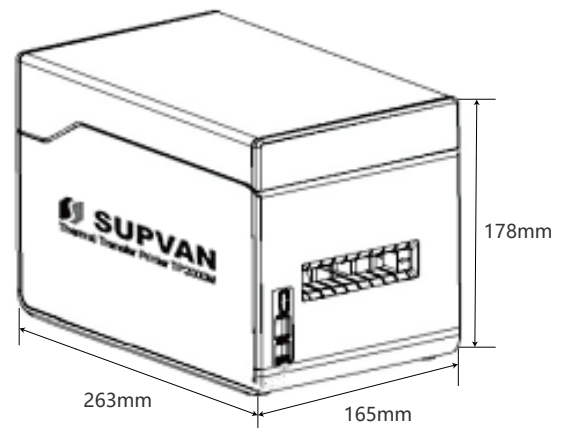

Included Items



Packing box x 1



TP2000M Printer x 1



Ribbon x 1



USB cable x 1



Power adapter x 1



Power line x 1



CD-ROM

Consumables of TP2000M

TP2000M







Printer	Picture	Consumable Type	Model No.	Specification
 <p>TP2000M</p>		Black ribbon 	TP-R453BKE	55mm*45m/roll
		White ribbon 	TP-R453WTE	55mm*45m/roll
		Golden ribbon 	TP-R453GLE	55mm*45m/roll
		Tube Support	-	Accessory for Heat shrink tube

Plate Printer

- 1 Different printing materials: Hard plate(PVC,ABS), label: Continuous label.
- 2 High resolution 300dpi, make words clear.
- 3 Automatic continuous deliver plate, improve your work efficiency.
- 4 Printing speed 6pcs/min(32mm*68mm ABS/PVC)
- 5 Automatic cleaning function, keep clean when you print.
- 6 USB PC connection, import data from excel, make plates in bulk on PC.



SP650E

Application



Specification

Project	Parameter
Model	SP650E
Printing method	Thermal transfer
Resolution	300dpi
Feed Grade	Automatic continuous deliver plate
Feed capacity	The thickness of all plates≤50mm,50pcs/time(1mm/pcs)
Max. Print Width	57mm
Max. Print Length	ABS/PVC Plastic:546mm,Label:1196mm
Ribbon color	Single(black,red,green,blue,gold,sliver)
Ribbon size	60mm*130mm
Media type	Plate:Hard plate(PVC,ABS) Label: Continuous label
Media thickness	ABS/PVC Hard plate:0.2mm-3mm, Label:0.2mm-1mm
Media width	20mm-80mm
Media length	ABS/PVC Hard plate:50mm-550mm, Label:50mm-1200mm
Printing interface	USB2.0
Printing speed	6pcs/min(32mm*68mm ABS/PVC)
Clean type	Automatic
Edit software	Supvan series Edit software
Operation system	Xp/ Win7/ Wind8/Win10
Dimension(L×W×H)	440mm*250mm*214mm
Weight	11kg
Operating environment	15 C -35 C ,15%-80% No condensation
Power supply	AC adapter(Input voltage:AC 100V-240V 50/60Hz)
Operation button	1.Feed button/2.Clean button/3.Rewind button/4.Cancel button
Warranty	2 years,printer:1year

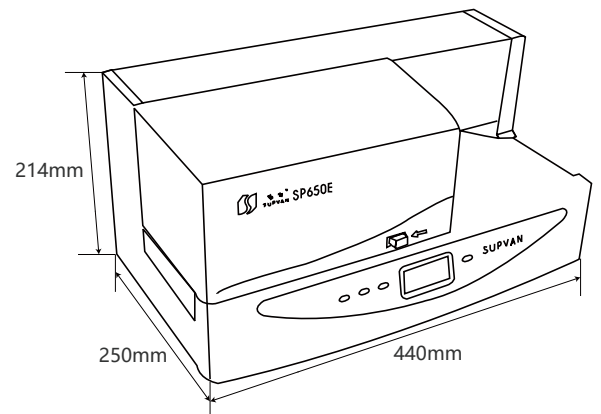













Included Items



Packing box x 1 SP650E Printer x 1 Ribbon Cassette x 1 Cleaning Tape x 1 Compression block x 1 Power line x 1 USB Cable x 1 Plates x 1 User Manual x 1

Consumables of SP650E

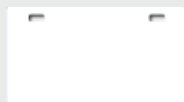
SP650E

Printer	Picture	Consumable Type	Model No.	Specification
 <p>SP650E</p>		Black ribbon 	SP-R130EBK	60mm*130m/roll
		White ribbon 	SP-R100EWT	60mm*100m/roll
		Red ribbon 	SP-R130ERD	60mm*130m/roll
		Green ribbon 	SP-R130EGN	60mm*130m/roll
		Blue ribbon 	SP-R130EBU	60mm*130m/roll
		Golden ribbon 	SP-R130EGD	60mm*130m/roll
		Silver ribbon 	SP-R130ESL	60mm*130m/roll
		Brushed Silver Self Adhesive Label	SP-L70050S	70mm*50m/roll
		Brushed Silver Self Adhesive Label	SP-L50050S	50mm*50m/roll
		Plate (Single hole)	C-32681	32mm*68mm/pc
		Plate (Double holes)	C-30602	30mm*60mm/pc
		Cleaning Tape	SP-CF	73mm*6m/roll

JOHANNESBURG



MIMIC COMPONENTS

ELECTRICAL & ELECTRONIC
WHOLESALE DISTRIBUTORS
SOUTHERN AFRICA

Address

5 Ramsay Street, Booyens,
2091 Johannesburg,
South Africa

P.O. Box 38493 Booyens,
2016 South Africa

Telephone:
Switchboard: +27 (0)11- 689-5700

Website: www.mimiccomponents.co.za
Email: info1@mimiccomponents.co.za

CAPE TOWN



MIMIC CAPE

ELECTRICAL & ELECTRONIC
WHOLESALE DISTRIBUTORS
SOUTHERN AFRICA

Address

Unit 41A, Stella Park,
57 Stella Road, Montague Gardens,
Cape Town, 7441, South Africa

PO. Box 36955 Chempet,
7442 South Africa

Telephone:
Switchboard: +27(0) 21-551-8185

Website: www.mimic-cape.co.za
Email: info@mimic-cape.co.za



MIMIC COMPONENTS sales@mimic.co.za www.mimic.co.za TEL: +27(0)11 689-5700
5 Ramsay Street, Booyens 2091, Johannesburg PO. Box 38493, Booyens 2016, Johannesburg, South Africa



MIMIC CAPE anje@mimics.co.za www.mimic.co.za TEL: +27(0)21-551-8185 FAX: +27(0)21-551-8169
Unit 41A, Stella Park, 57 Stella Road, Montague Gardens, Cape Town 7441. PO Box 36955 Chempet 7442 South Africa